



Two-port seat valves with female threads, ANSI class 250 (PN16)

VVI44...
VVI44...J

- Bronze UNS CA 844
- Female threaded to ISO 7-1
- DN15 ... DN25 mm (½" ... 1")
- k_{vs} 0.34 ... 8.6 m³/h
- Stroke 5.5 mm
- Manual adjustment by means of mounted knob (optional)
- Can be equipped with SQS... or SSC... actuators
- Available with brass trim (standard versions VVI44...)
or stainless steel trim (special versions VVI44...J)

Use

In small size heating-, ventilation- and air conditioning plants as control- or safety shut off valve to control the supply of hot or chilled water to fan coil units, radiators, reheat coils and similar terminal units. **For closed loops only.**

To operate the valve, an actuator, delivering at least 300N of force is required.

Media

- Hot water: max. 120 °C
- Chilled water: above 2 °C
- Water containing anti-freeze agents

Recommendation

Water should be treated as specified in VDI 2035

Operating pressure

ANSI Class 250 (PN16)

Type summary

Standard versions with brass trim

Type	DN [mm]	k_{VS} [m ³ /h]	S_v	Δp_S [kPa]	Δp_{Vmax} [kPa]
VVI44.15-0.34	15	0.34	> 50	655	200
VVI44.15-0.54		0.54			
VVI44.15-0.85		0.85			
VVI44.15-1.37		1.37	> 100		
VVI44.15-2.15	2.15	345			
VVI44.20-3.44	20			3.44	
VVI44.20-5.43		5.43		276	
VVI44.25-8.6	25	8.6			

Special versions with stainless steel trim

Type	DN [mm]	k_{VS} [m ³ /h]	S_v	Δp_S [kPa]	Δp_{Vmax} [kPa]
VVI44.15-0.34J	15	0.34	> 50	655	400
VVI44.15-0.54J		0.54			
VVI44.15-0.85J		0.85			
VVI44.15-1.37J		1.37	> 100		
VVI44.15-2.15J	2.15	345		300	
VVI44.20-3.44J	20				3.44
VVI44.20-5.43J		5.43		276	250
VVI44.25-8.6J	25	8.6			

DN Nominal diameter

k_{VS} Flow rate in m³/h of water at 5 ... 30 °C through the valve at nominal stroke (100 %) and at a differential pressure of 1 bar.

k_{VR} Minimum flow rate through the valve in m³/h at a differential pressure of 1 bar, at which the flow-characteristic tolerances can still be maintained.

S_v Rangeability (k_{VS} / k_{VR})

Δp_S Max. admissible differential pressure, at which the valve/actuator unit closes reliably against the pressure (close off pressure).

Δp_{Vmax} Max. admissible differential pressure across the full positioning range of the valve. (Max. recommended operating pressure drop)

Accessories

Type		Description
4 2068 8895 0		<ul style="list-style-type: none"> – Protective knob to cover the bonnet and threads. – Manual override to open the valve to maximum 70 %.

Ordering

When ordering, please specify the quantity, product name and type reference. Minimum order quantity is 10 pieces or multiples of 10 pieces.

Example

10 pieces two-port valve, type VVI44.25-8.6J

Delivery

The valves are shipped in bulk packaging containing 10 pieces.

Equipment combinations

Valve types VVI44...(J) are operated with Siemens actuators type SQS... or SSC...:

Valvetype	H ₁₀₀ [mm]	Actuators ¹⁾			
		SQS...		SSC...	
		Δp_{max}	Δp_s	Δp_{max}	Δp_s
		[kPa]			
VVI44.15-0.34(J)	5.5	200 (400)	655	200 (400)	655
VVI44.15-0.54(J)					
VVI44.15-0.85(J)					
VVI44.15-1.37(J)					
VVI44.15-2.15(J)		200 (300)	345	200 (300)	345
VVI44.20-3.44(J)					
VVI44.20-5.43(J)		200 (250)	276	200 (250)	276
VVI44.25-8.6(J)					
Data sheet		4573		4895	

¹⁾ Available actuators:

- AC 24 V or AC 230 V with 3-position signal
- AC 24 V with DC 0 ... 10 V proportional position signal

H₁₀₀ 100 % stroke of valve and actuator

Δp_{max} Max. admissible differential pressure across the full positioning range of the valve/actuator unit.
(Max. recommended operating pressure drop)
Values in brackets are valid for the valves with stainless steel trim.

Δp_s Max. admissible differential pressure, at which the valve/actuator unit closes reliably against the pressure (close off pressure).

Technical Design

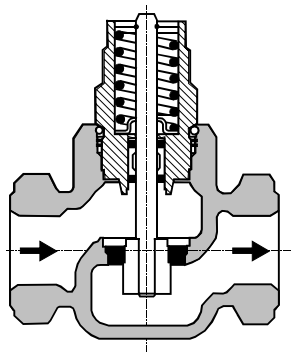

The valve is of the «normally closed» design, where the return spring provides the necessary force to pull the plug against the seat.

In the event of a power failure, a fail-safe actuator returns the plug to its closed position, while a fail in place actuator will hold the last commanded valve plug position.

Flow diagram

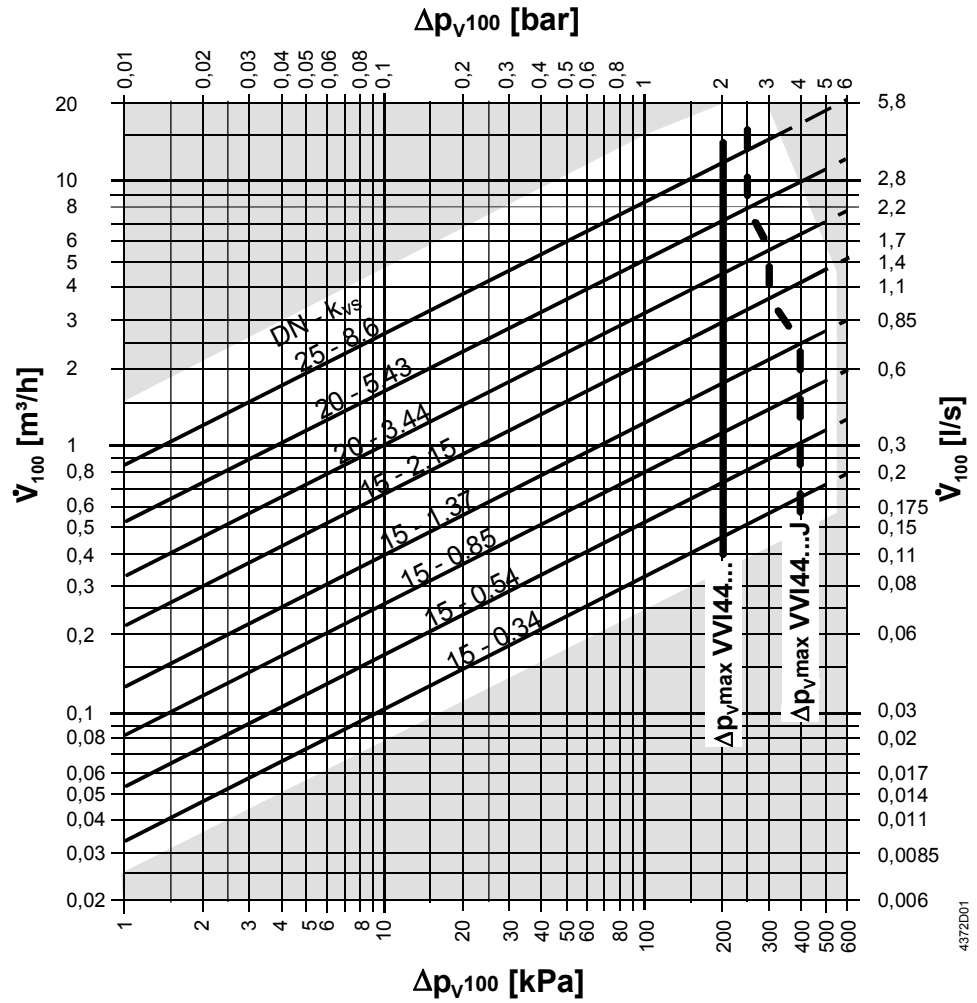

Δp_{Vmax} Max. admissible differential pressure across the full positioning range of the valve.
 — VVI44...: Standard versions with brass trim
 - - - VVI44...J: Special versions with stainless steel trim

Δp_{V100} Admissible differential pressure with fully open valve at nominal stroke
 V_{100} Maximum flow rate in m^3/h or l/s
 100 kPa = 1 bar \approx 10 mWG
 1 m^3/h = 0.278 kg/s water at 20 °C

Valve flow characteristic

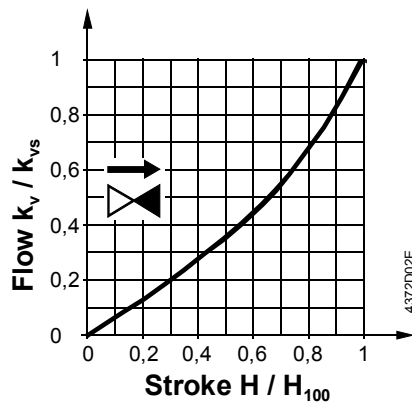

Valve flow characteristic:
 Equal percentage,
 optimised for a wide controllable range

Notes

Engineering

Water quality requirements as per VDI 2035.

Note

We recommend installing a strainer upstream of the valve to ensure long-term functional safety.

Mounting

Both valve and actuator can easily be assembled at the mounting location. Neither special tools nor adjustments are required.

The valve is supplied with mounting instructions.

Orientation

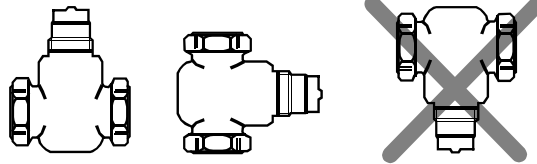

permissible

not permissible

Direction of flow

When mounting, pay attention to the valve's flow direction symbol: 

Commissioning

Commission the valve using the mounted manual adjustment button (optional, see «Accessories») or a correctly mounted actuator.

- Stem retracts: Increasing flow
- Stem extends: Decreasing flow

Maintenance

When servicing the valve:

- Switch OFF the pump and power supply, close the main shut-off valves in the pipework, release pressure in the pipes and allow them to cool down completely.
- If necessary, disconnect electrical connections from terminals.
- The valve must be re-commissioned only with the actuator correctly assembled.

Stem sealing gland

The stem sealing gland cannot be exchanged. In the case of leakage, the entire valve must be replaced, whereby the information provided in «Maintenance» must be observed. Contact your local office or branch.

Disposal

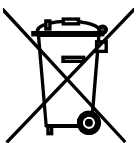

The various material types used require that you disassemble the unit and sort the components prior to disposal.

Current local legislation must be observed.

Warranty



The technical data given for these applications is valid only for valves used in conjunction with the actuators described under «Equipment combinations».

The use of valve type VVI44...(J) with third-party actuators invalidates any warranty offered by Siemens Building Technologies / HVAC Products.

Technical data

Operating data	Characteristics	Modified equal percentage, optimised for a wide controllable range
	Leakage	0...0.02 % of k_{vs}
	Rangeability	See «Type summary»
	Pressure class PN16	Acc. to ISO 7268 (DIN 2401)
	ANSI Class 250	ASME B16.15
	Nominal stroke	5.5 mm
	Temperature range	+2 ... +120 °C
Materials	Valve body	Bronze UNS CA 844
	Stem	Stainless steel ASTM A582 Type 303
	Plug, seat, gland	Brass or stainless steel
	O-rings	Special EPDM rubber
Dimensions / Weight	Dimensions	See «Dimensions» (table)
	Threaded connections	Rp... to ISO 7/1
	Weight	See «Dimensions» (table)

Dimensions

All dimensions in mm

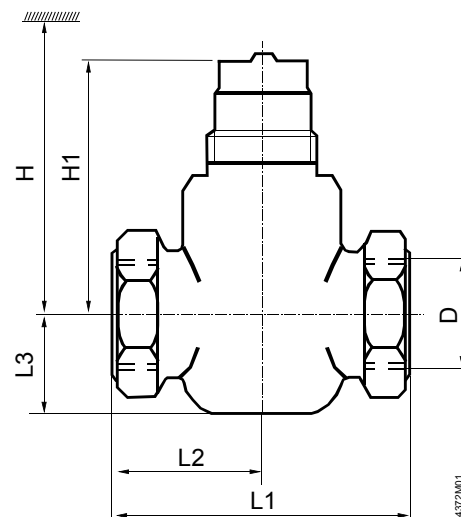

DN [mm]	D [inch]	H SQS...	H SSC	H1	L1	L2	L3	W [kg]
15	Rp $\frac{1}{2}$ "	> 372	> 336	61	70	35	24	0.60
20	Rp $\frac{3}{4}$ "	> 372	> 336	61	82	41	26	0.80
25	Rp1"	> 378	> 342	67	98	49	30	1.20

- H Overall height of valve from centre of pipe with actuator (SQS... or SSC...) plus minimum clearance (>200 mm) from ceilings or walls for mounting, connection, operation, service etc.
H1 Installation height from centre of pipe, for actuator (upper edge)
W Weight incl. packaging